



# **GRINDMASTER 512™**

## **Industrial Grinder**

### **Manual 1:**

### **Operating Instructions**







# **GRINDMASTER 512™**

## **Industrial Grinder**

### **Manual 1:**

# **Operating Instructions**

DuraTech Industries International Inc. (DuraTech) has made every effort to assure that this manual completely and accurately describes the operation and maintenance of the GRINDMASTER 512™ as of the date of publication. DuraTech reserves the right to make updates to the machine from time to time. Even in the event of such updates, you should still find this manual to be appropriate for the safe operation and maintenance of your unit.

This manual, as well as materials provided by component suppliers to DuraTech are all considered to be part of the information package. Every operator is required to read and understand these manuals, and they should be located within easy access for periodic review.

 is a registered trademark of Duratech Industries International, Inc. GRINDMASTER 512 is a trademark of Duratech Industries International, Inc.

---





## FOREWORD



## Foreword

### Appropriate use of the unit

This Industrial Grinder is designed to grind industrial waste and other materials, including wood waste, construction and demolition debris, asphalt, bricks, concrete blocks, tree branches and trunks, compostables and mulch. It is **NOT** designed to grind steel.

### Operator protection

As with all machinery, care needs to be taken by the operator in order to insure the safety of the operator and those in the surrounding area.



**WARNING:** Operators and those observing the operation of the Industrial Grinder are required to wear head, eye, and ear protection. No loose clothing is allowed.



## TABLE OF CONTENTS

<b>Manual 1: Operating Instructions .....</b>	<b>1</b>
<b>Introduction .....</b>	<b>2</b>
<b>Purpose .....</b>	<b>2</b>
<b>Section 1: Safety .....</b>	<b>3</b>
1.1 Safety-alert symbols .....	4
1.2 Operator - personal equipment .....	6
1.3 Machine safety labels .....	7
1.4 Shielding .....	9
1.5 Industrial Grinder safety review .....	9
1.6 Thrown objects and operator safety .....	10
1.7 Service and maintenance .....	10
1.8 Personal protection equipment .....	10
1.9 Fire safety .....	11
1.10 Important safety reminders .....	11
1.11 Towing .....	11
<b>Section 2: Introduction .....</b>	<b>12</b>
2.1 Description of the DuraTech GRINDMASTER 512 .....	12
2.2 Carrier and Chassis .....	12
2.3 Rotor .....	12
2.4 Engine .....	13
2.5 Hydraulics .....	13
2.6 Screens .....	14
2.7 Drive Belts .....	15
2.8 Conveyor .....	15
2.9 Wheels and Tires .....	16
2.10 Fuel System .....	16
2.11 Engine Cooling System .....	16
2.12 Hydraulic cooler .....	16
2.13 Starting System .....	17
2.14 Lights .....	17
2.15 Overview of the 512 operator controls .....	17



## TABLE OF CONTENTS

<b>Section 3: Operation .....</b>	<b>20</b>
3.1 Pre-operation inspection .....	20
3.2 Starting the GRINDMASTER 512 .....	21
3.3 Automatic engine shutdown system .....	22
3.4 Normal Shutdown Procedure .....	22
3.5 Emergency Shutdown Procedure .....	23
3.6 Grinding Materials .....	24
3.7 Clearing Jams .....	26
3.8 Belt Tracking .....	27
3.9 Conveyor .....	30
3.10 Preparing the 512 for transport .....	31
3.11 Preparing the 512 for operation after transport .....	32
3.12 Preparing the 512 for storage .....	32
3.13 Removing the 512 from storage .....	32
<b>Section 4: Engine Maintenance .....</b>	<b>33</b>
<b>Section 5: General Maintenance .....</b>	<b>33</b>
5.1 Batteries .....	33
5.2 Lubrication .....	34
5.3 Hydraulic system .....	38
5.4 Axle, wheels and tires .....	39
5.5 Brake component lubrication .....	40
5.6 Rotor bearing installation .....	41
5.7 Rotor bearing maintenance .....	44
5.8 Seal Replacement .....	44
<b>Appendix A: Warranty .....</b>	<b>45</b>
<b>Appendix B: Specifications .....</b>	<b>46</b>
<b>GRINDMASTER 512 Documentation Comment Form .....</b>	<b>47</b>



## TABLE OF CONTENTS







# **GRINDMASTER 512™**

## **Manual 1: Operating Instructions**



# Introduction

Your model GRINDMASTER 512™ is designed to grind industrial waste and other materials, including wood waste, construction and demolition debris, asphalt, bricks, concrete blocks, tree branches and trunks, compostables and mulch. It is **NOT** designed to grind steel.

## Purpose

The purpose of this owner's manual is to explain maintenance requirements and routine adjustments for the most efficient operation of your GRINDMASTER 512. There is also a trouble shooting section that may help in case of problems in the field. Any information not covered in this manual may be obtained from your dealer.



**SPECIAL NOTE:** When reference is made as to front, rear, left hand, or right hand of this machine, the reference is always made from standing at the rear end of the machine and looking toward the hitch. Always use serial number and model number when referring to parts or problems. Please obtain your serial number and write it below for your future reference.

MODEL: GRINDMASTER 512

SERIAL NO. \_\_\_\_\_

## How to use the manual

### Manual organization

This manual is organized into the following parts:

- **Manual 1: Operating instructions** explain how to set up, use and maintain the GRINDMASTER 512.

### Dealer responsibilities

- Thoroughly review this section, "Dealer Responsibilities," and perform the tasks outlined. Also perform a daily pre-operation inspection as described in Section 3, "Operation."
- Upon delivery of the unit to the customer, it is the dealer's responsibility to conduct a training session on the safe operation of the unit for the primary operator(s). Dealer must also conduct a "walk-around" inspection of all safety instructional decals on the machine itself.



- When dealer is satisfied that the primary operators have read the operating instructions, and understand all information concerning the safe operation of the unit, sign and return the User Training Verification Form found in the GRINDMASTER 512 documentation packet. Note that this form requires both the dealer's signature and the signatures of up to four primary operators.
- Complete and return the Delivery Notification Form found in the GRINDMASTER 512 documentation packet. Receipt of this form is required to activate the warranty. Appendix A provides details of the warranty.

## **Operator responsibilities**

- The operator is responsible for his own safety.
- The operator is responsible for the safety of all others in the area.
- Review "Dealer Responsibilities," to verify that the machine has been prepared for use.
- Note the important safety information in the Foreword and in Section 1, "Safety."
- Thoroughly review sections 1 through 3 which explain normal operation of the machine, and section 5 which explain maintenance requirements. These sections will function as a textbook during the dealer-conducted training course that is required before use of the unit.
- When all primary operators have read the operating instructions and understand all information concerning the safe operation of the unit, the dealer will be required to sign the User Training Verification Form found the 512 documentation packet. Note that this form requires both the dealer's signature and the customer's signature. The dealer is responsible for returning the signed form to DuraTech Industries.
- Manuals for certain third-party components are provided separately. The operator must also be familiar with their contents.
- Keep copies of all manuals in a readily-accessible location for future reference.

## **Section 1: Safety**

Thank you for taking the time to read the operation and maintenance manual for the DuraTech GRINDMASTER 512. Because your safety and that of others is of the utmost importance, you should familiarize yourself with this entire manual before operating this unit.

The 512 incorporates a number of third party products. For example, the engine, and hydraulic pumps are third party products. More information about the operation and care of these products can be found in each product's respective manual(s). Before operating this unit, you should familiarize yourself with these manuals as well.

Safety is an ongoing job experience, and DuraTech has made every effort to make sure that the GRINDMASTER 512 provides operator comfort and security. DuraTech encourages you to bring to our attention as quickly as possible any suggestions you may have concerning the safety of the equipment. DuraTech is dedicated to enhancing the safety of the GRINDMASTER 512.



This unit is supplied with an operation and maintenance manual and this manual should be kept with the unit for periodic review by operational personnel.

Operators of the 512 are required to wear head, eye, and ear protection as well as clothing appropriate for the application. Individuals with loose clothing, unrestrained long hair, jewelry, or other accessories which may hang loosely away from the body should not be allowed on or near the machine.



**WARNING:** FAILURE TO COMPLY WITH SAFETY INSTRUCTIONS THAT FOLLOW WITHIN THIS MANUAL COULD RESULT IN SEVERE PERSONAL INJURY OR DEATH. BEFORE ATTEMPTING TO OPERATE THIS MACHINE, CAREFULLY READ ALL INSTRUCTIONS CONTAINED WITHIN THIS MANUAL.

**THIS MACHINE IS NOT TO BE USED FOR ANY PURPOSE OTHER THAN THOSE EXPLAINED IN THE OPERATOR'S MANUAL, ADVERTISING LITERATURE OR OTHER DURATECH WRITTEN MATERIAL PERTAINING TO THE GRINDMASTER 512.**

## 1.1 Safety-alert symbols

Decals are illustrated in **Manual 2: Parts Reference**.

The safety decals located on your machine contain important and useful information that will help you operate your equipment safely.

To assure that all decals remain in place and in good condition, follow the instructions below:

- Keep decals clean. Use soap and water - not mineral spirits, adhesive cleaners and other similar cleaners that will damage the decal.
- Replace all damaged or missing decals. When attaching decals, surface temperature of the machine must be at least 40° F (5° C). The surface must be also be clean and dry.
- When replacing a machine component to which a decal is attached, be sure to also replace the decal.
- Replacement decals can be purchased from your DuraTech dealer.



DuraTech uses industry accepted ANSI standards in labeling its products for safety and operational characteristics.



## Safety-Alert Symbol

Read and recognize safety information. Be alert to the potential for personal injury when you see this safety-alert symbol.

**DANGER:** Indicates an imminently hazardous situation that, if not avoided, will result in death or serious injury. This signal word is to be limited to the most extreme situations, typically for machine components that, for functional purposes, cannot be guarded.



**DANGER:**  
Signal word - White Lettering/Red Background  
Safety Alert Symbol - White Triangle/Red Exclamation Point

**WARNING:** Indicates a potentially hazardous situation that, if not avoided, could result in death or serious injury, and includes hazards that are exposed when guards are removed. It may also be used to alert against unsafe practices.



**WARNING:**  
Signal word - Black Lettering/Orange Background  
Safety Alert Symbol - Black Triangle/Orange Exclamation Point

**CAUTION:** Indicates a potentially hazardous situation that, if not avoided, may result in minor or moderate injury. It may also be used to alert against unsafe practices.



**CAUTION:**  
Signal word - Black Lettering/Yellow Background  
Safety Alert Symbol - Black Triangle/Yellow Exclamation Point

This manual uses the symbols to the right to denote important safety instructions and information.

The **DANGER**, **WARNING** and **CAUTION** symbols are used to denote conditions as stated in the text above. Furthermore, the text dealing with these situations is surrounded by a box with a white background, will begin with **DANGER**, **WARNING**, or **CAUTION**.

The **INFORMATION** symbol is used to denote important information or notes in regards to maintenance and use of the machine. The text for this information is surrounded by a box with a light grey background, and will begin with either **IMPORTANT** or **NOTE**.





## 1.2 Operator - personal equipment

### THE OPERATOR

#### Physical Condition

You must be in good physical condition and mental health and not under the influence of any substance (drugs, alcohol) which might impair vision, dexterity or judgment.

Do not operate a **GRINDMASTER 512** when you are fatigued. Be alert - If you get tired while operating your **GRINDMASTER 512**, take a break. Fatigue may result in loss of control. Working with any industrial equipment can be strenuous. If you have any condition that might be aggravated by strenuous work, check with your doctor before operating

#### Proper Clothing



Clothing must be sturdy and snug-fitting, but allow complete freedom of movement. Avoid loose-fitting jackets, scarfs, neckties, jewelry, flared or cuffed pants, unconfined long hair or anything that could become entangled with the machine.



Protect your hands with gloves when handling machinery. Heavyduty, nonslip gloves improve your grip and protect your hands.



Good footing is most important. Wear sturdy boots with nonslip soles. Steel-toed safety boots are recommended.



To reduce the risk of injury to your eyes never operate a **GRINDMASTER 512** unless wearing goggles or properly fitted safety glasses with adequate top and side protection.



Machine noise may damage your hearing. Always wear sound barriers (ear plugs or ear muffers) to protect your hearing. Continual and regular users should have their hearing checked regularly.



### 1.3 Machine safety labels

The safety decals located on your machine contain important information that will help you operate your equipment. Become familiar with the decals and their locations.

 **DANGER: OBJECTS THROWN BY MACHINE.**

Do not operate without wearing safety glasses and a hard hat. Keep unauthorized personnel out of the grinding area!



6500118

 **WARNING: FOR YOUR PROTECTION AND SAFETY OF OTHERS, FOLLOW THESE SAFETY RULES.**

1. Read and understand operators manual before operating machine.
2. Place all controls in neutral, stop engine, remove ignition key, lock out power source, and wait for all motion to stop before servicing, adjusting, repairing, or unplugging.
3. Read and understand all decals on machine for your safety.
4. Keep all shields in place while machine is in operation.
5. Keep hands, feet, hair, and clothing away from moving parts.
6. Keep others away from machine while in operation.
7. Install safety locks before transporting, or working beneath components.
8. Do not allow riders at any time.
9. Do not leave machine unattended with engine running.
10. Keep all hydraulic lines, couplings, and fittings free of leaks during operation.
11. Keep away from overhead electrical lines. Electrocutation can occur without direct contact.
12. Review safety instructions periodically.



6500208



**WARNING: HIGH-PRESSURE FLUID HAZARD**

To prevent serious injury or death:

- Relieve pressure on system before repairing or adjusting or disconnecting.
- Wear proper hand and eye protection when searching for leaks. Use wood or cardboard instead of hands.
- Keep all components in good repair.

 <b>WARNING</b>	
	
<p><b>HIGH-PRESSURE FLUID HAZARD</b> To prevent serious injury or death:</p> <ul style="list-style-type: none"><li>• Relieve pressure on system before repairing or adjusting or disconnecting.</li><li>• Wear proper hand and eye protection when searching for leaks. Use wood or cardboard instead of hands.</li><li>• Keep all components in good repair.</li></ul> <small>6500220</small>	

**6500220**



**CAUTION: KEEP WHEEL BOLTS TIGHT**

<p><b>KEEP WHEEL BOLTS TIGHT</b></p> <p><b>MANTENER AJUSTADOS LOS PERNOS DE LA RUEDA</b></p> <small>6500220</small>
---

**6500220**





## 1.4 Shielding

The GRINDMASTER 512 is equipped with shielding. All Shields should be kept in place during operation. Bodily injury may occur if the unit is operated without shields.



**WARNING:** Shields are installed for your protection and to keep material off machine parts. Do not operate this Industrial Tub Grinder without shields in place and in operating condition.

## 1.5 Industrial Grinder safety review



**WARNING:** Before attempting to operate your GRINDMASTER 512, carefully read and follow instructions given below and contained elsewhere in this manual.

Each and every aspect of the DuraTech Grindmaster should be reviewed by each operator on a frequent basis. Safety systems are in place that result in direct operator security.

- Keep all foreign objects including rocks, pieces of metal and other incompressibles out of the hopper and away from the rotor. A thrown foreign object may cause injury or damage to the machine. A foreign object is any object which the unit is not designed to grind.
- Allow only responsible, properly instructed individuals to operate machines. Carefully supervise inexperienced operators.
- **Never operate the unit without all safety features, including shields, in place and in operating condition.**
- Make no modifications to this equipment unless specifically requested or recommended by DuraTech Industries.
- Tighten or replace any loose or cracked bolts, chains, hoses or connections.
- Check overhead for electrical power lines or other obstructions and be certain there is adequate clearance.
- Allow no one on the Grindmaster at any time during operation.
- Unauthorized personnel should stay out of the grinding area.
- Always perform the pre-operation inspection before operating this machine.
- Ensure rotor is at a complete stop and engine is shut down before any performing any maintenance.



**WARNING:** Loose clothing, necklaces and similar items are easily caught in moving parts. Avoid the use of these items if possible. Keep long hair confined. Keep hands, feet and clothing away from power driven parts.



## 1.6 Thrown objects and operator safety

An operational characteristic of all grinders is that objects may be thrown out of the hopper. Thrown objects may present a safety hazard to persons in the area. This section is to inform the operator of this characteristic, and what can be done to reduce the risk of injury to the operator and persons in the area. Material may be thrown towards the front of the GRINDMASTER 512. Keep all observers away from the machine, any personnel permitted on the machine must be in the cab while the grinder is operating.

## 1.7 Service and maintenance



**WARNING:** The stored up energy in the rotor causes it to rotate after the drive has been disengaged. Before performing any maintenance on the machine or getting into the hopper, be sure rotor and all moving parts have come to a complete stop. Shut off engine, remove the key and tag the machine out for maintenance.

- Before working on or near the GRINDMASTER 512 for any reason such as servicing, inspecting or unclogging the machine:
- Follow the normal shutdown procedure found in this manual.
- If the unit is still attached to a towing vehicle, place the towing vehicle's transmission in park and set the parking/emergency brake.
- Relieve all pressure in the hydraulic system before disconnecting hydraulic lines or performing work on the system. Make sure all connections are tight and the hoses and lines are in good condition before applying pressure to the system.



**WARNING:** Hydraulic fluid escaping under pressure can be invisible and have enough force to penetrate the skin. When searching for a suspected leak, use a piece of wood or a cardboard rather than your hands. If injured, seek medical attention immediately to prevent serious infection or reaction.

When replacing any part on your GRINDMASTER 512, be sure to use only DuraTech authorized parts.

## 1.8 Personal protection equipment

Operators and authorized observers of the GRINDMASTER 512 are required to wear head, eye, and ear protection. No loose clothing is allowed.



## 1.9 Fire safety

Locate adequate fire extinguishing equipment (fire extinguisher, fire hose, etc..) prior to start-up or operation of the unit. At shutdown, always clean off the unit using high-pressure air or water. **Remove all debris from around the radiator, turbo charger, manifold, air intake, top of engine, and all moving parts.**

## 1.10 Important safety reminders



**WARNING:** Always follow basic safety precautions when using this unit to reduce the risk of injury.

**NEVER** perform maintenance in the hopper, under the machine, on the conveyor, or other moving part of the machine without first shutting off the engine and removing the key.

Unauthorized personnel should stay out of the grinding area. Flying debris can injure inattentive personnel.

**NEVER** climb on, crawl under, or enter the hopper when the engine is running or the machine is in operation.

**NEVER** leave the vicinity of the unit with the engine running.

## 1.11 Towing

Check all lights, brakes and hitch connections before towing. Check your state laws regarding the use of lights, safety chains, moving wide loads on public roads, and other possible requirements.

Use caution when traveling on public roads, rough or winding roads, or steep terrain.



**WARNING:** FAILURE TO COMPLY WITH ANY OF THE PRECEDING SAFETY INSTRUCTIONS OR THOSE THAT FOLLOW WITHIN THIS MANUAL MAY RESULT IN SEVERE INJURY OR DEATH.

**THIS GRINDER IS NOT TO BE USED FOR ANY PURPOSE OTHER THAN DEFINED IN THE OPERATOR'S MANUAL, ADVERTISING MATERIALS AND OTHER PERTINENT WRITTEN MATERIAL PREPARED BY DURATECH INDUSTRIES INTERNATIONAL, INC.**



## Section 2: Introduction

### 2.1 Description of the DuraTech GRINDMASTER 512

The GRINDMASTER 512 is designed to grind construction and demolition debris, asphalt, bricks, and concrete blocks. It will also grind wood waste, green waste, tree branches and trunks, compostables and mulch. The unit incorporates a number of basic features including the operator's compartment, carrier and chassis, debris hopper, rotor, water cooled diesel engine, hydraulic system, discharge conveyor, and the axle and hitch assemblies.

Material is fed into the hopper of the unit by appropriate means, such as a wheel loader. As the push box moves the material rearward, the material is exposed to the rotor. The rotor then grinds up the material before the material is discharged by the discharge conveyor.

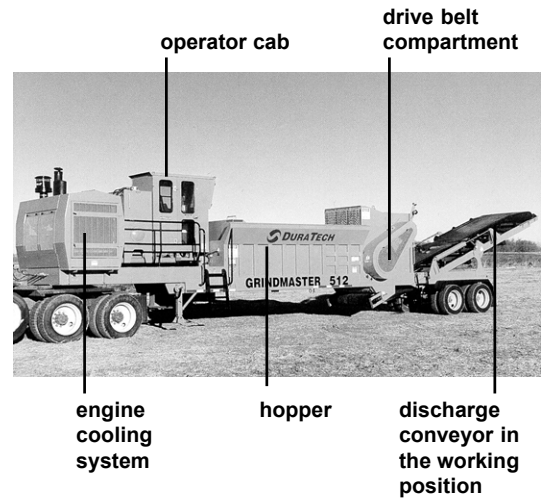

### 2.2 Carrier and Chassis

The grinder is mounted to tandem axle trailer chassis with DOT approved brakes and lighting. The chassis is equipped with a standard tow plate that will mount to any truck tractor 5th-wheel.

The Grindmaster chassis is equipped with manually operated trailer dolly support jacks.

### 2.3 Rotor

The rotor can be equipped with three types of bits: asphalt bits, C&D bits, or wood bits, which shear material as it is forced against the shear bar. Each bit is individually bolted to a holder affixed to the drum face.

Bits may be individually replaced on an as needed basis, or group replaced if desired.

The rotor drive train consists of 4 major components:

- 425 HP Diesel Engine
- Pump Drive Gearbox
- Hydrostatic Pump
- Rotor Drive Motor

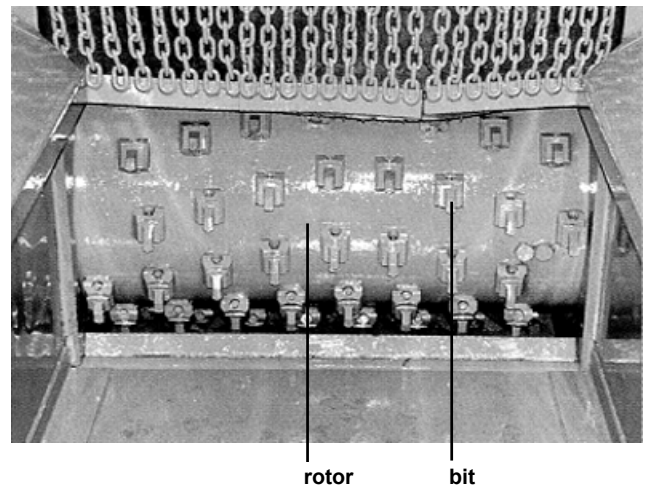



## 2.4 Engine

The grinder is powered by a water cooled, diesel engine. The engine is mounted on the front of the chassis. The engine provides power to the hydraulic drive system.

The engine is mounted with the radiator facing the left side of the vehicle, and the flywheel facing the right side of the vehicle.

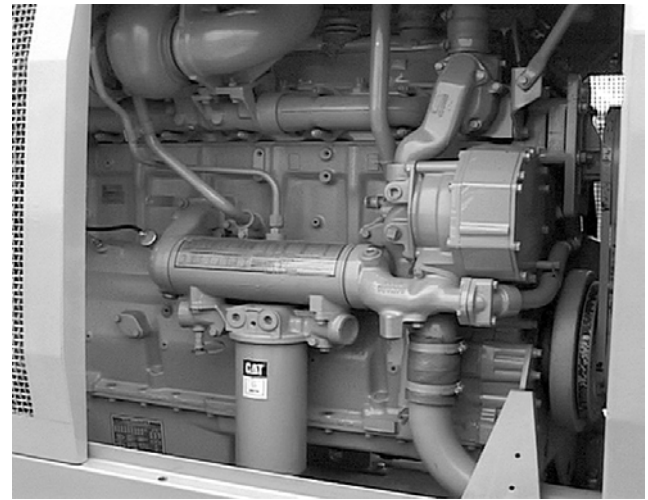

## 2.5 Hydraulics

The hydraulic system consists of a 200 gallon reservoir, pumps, motor cooler, and pressure and return line filters.

The GRINDMASTER 512 utilizes four hydraulic pumps:

1. Two variable displacement hydraulic pumps are driven directly by the engine to supply fluid energy to the rotor drive motors.
2. A fixed displacement hydraulic pump is driven from the accessory drive port on the engine to supply fluid energy to the push box cylinder and the shear bar lift cylinders.
3. A fixed displacement hydraulic pump is driven from an accessory drive port on the engine to supply fluid energy to the conveyor drive motor and conveyor fold cylinders.

The GRINDMASTER 512 utilizes the following hydraulic motors:

1. A hydraulic motor is utilized to transfer fluid energy to the right belt drive pulley.
2. A hydraulic motor is utilized to transfer fluid energy to the left belt drive pulley.
3. A hydraulic motor is utilized to transfer fluid energy to the conveyor drive shaft.

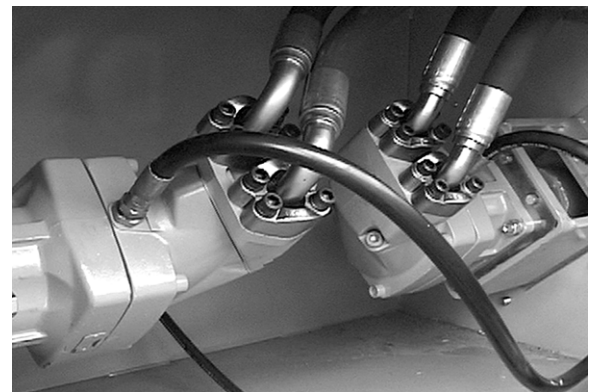

hydraulic motors

The Grindmaster also contains the following hydraulics:

1. A cooler to dissipate heat build up in the fluid power circuit.
2. A hydraulic cylinder to transfer fluid energy to the push box shaft.
3. A hydraulic cylinder to transfer fluid energy to the shear bar.
4. Manual mechanical control valves to control hydraulic flow to the system components.



A shuttle valve is located to the right rear of the rotor. Pushing the valve down provides power to run the conveyor motor. Raising the valve up provides power to the conveyor fold mechanism. For more information on folding and unfolding the conveyor see section 3.9.

**figure 2.1**  
conveyor fold lever and  
conveyor shuttle valve

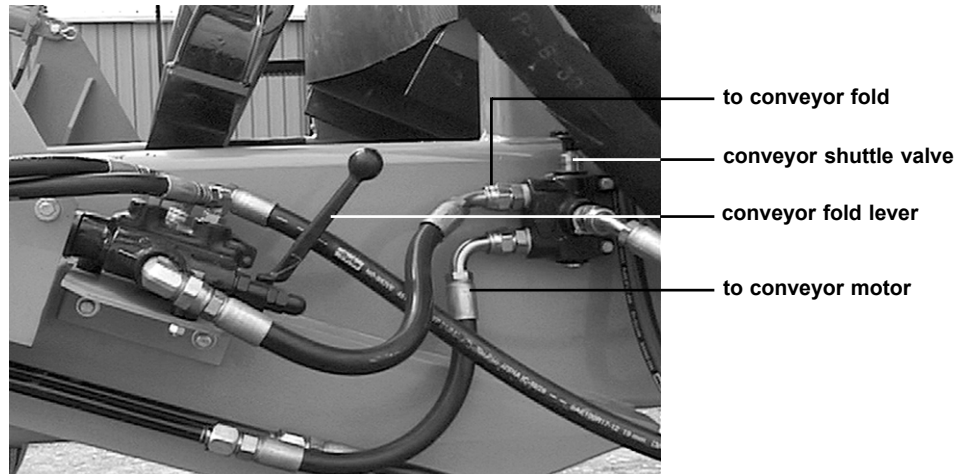

## 2.6 Screens

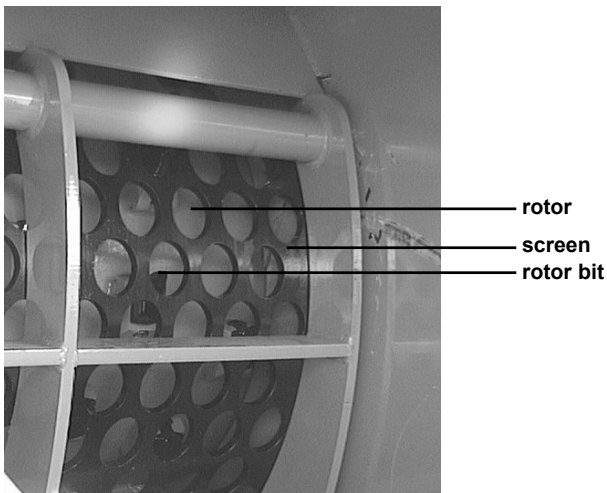

The 512 comes with a standard 2" x 5" slotted screen. Screens are also available in 2" x 4" diamond or 3" diameter hole patterns. A 6" x 7" demolition screen is also available. The demolition screen is used for size reduction on construction debris, demolition debris and wet materials.

Any combination of hole sizes may be used to alter the size of the outputted material. The size of the ground material is determined by the diameter of the screen holes. As the diameter of the screen holes becomes larger, the size of the ground material increases



**NOTE:** If a combination of screens with different hole diameters are used, the screen with the smallest hole diameter is normally placed on the front side of the screen track.



## 2.7 Drive Belts

One set of drive belts are located in each drive compartment. These belts are coupled to the pulley mounted on the end of the rotor shaft. The drive belt tension is maintained by adjusting bolts located in each drive compartment.

Adjust belts so there is 1/4" belt deflection with "thumb pressure".

figure 2.2  
belt drive compartment



drive belt  
tension  
adjusting  
bolt

## 2.8 Conveyor



**WARNING:** Fold conveyor before transporting.

A conveyor is mounted on the rear of the chassis and is used to move the ground material away from the unit.

The conveyor is mounted on and located around a series of rollers. The inside of the belt is equipped with a debris shield to prevent materials from being lodged between the conveyor belt and the front-most pivot/traction roller.

The conveyor may be folded to reduce the overall dimensions during transport or storage.



conveyor in the  
transport  
position



**NOTE:** When folding conveyor for transport make sure belt is securely tied down with strap. Not strapping down belt for transport will allow belt to drag on the highway.



## 2.9 Wheels and Tires

The trailer chassis uses tubeless tires. The tires are constructed with either a radial or bias-ply casing and a stabilizing belt of multiple layers.

## 2.10 Fuel System

One 175-gallon fuel tank supplies all of the fuel requirements of the grinder.

Fuel filters are provided to prevent passage of foreign material through the fuel lines into the engine.

An engine mounted fuel pump is utilized to pressurize the fuel system.

An electric fuel shutdown solenoid is utilized to control fuel flow to the engine. The solenoid is energized during operation to allow fuel flow to the engine.

## 2.11 Engine Cooling System

The engine cooling system uses a tube and fin, bolted radiator. The radiator uses a 50/50 mixture of water/antifreeze coolant.

The coolant pump is an integral part of the engine. The water pump is direct drive from the engine.

The system uses a coolant bypass, which allows circulation through the block until normal engine operating temperature is obtained.

figure 2.3  
radiator compartment

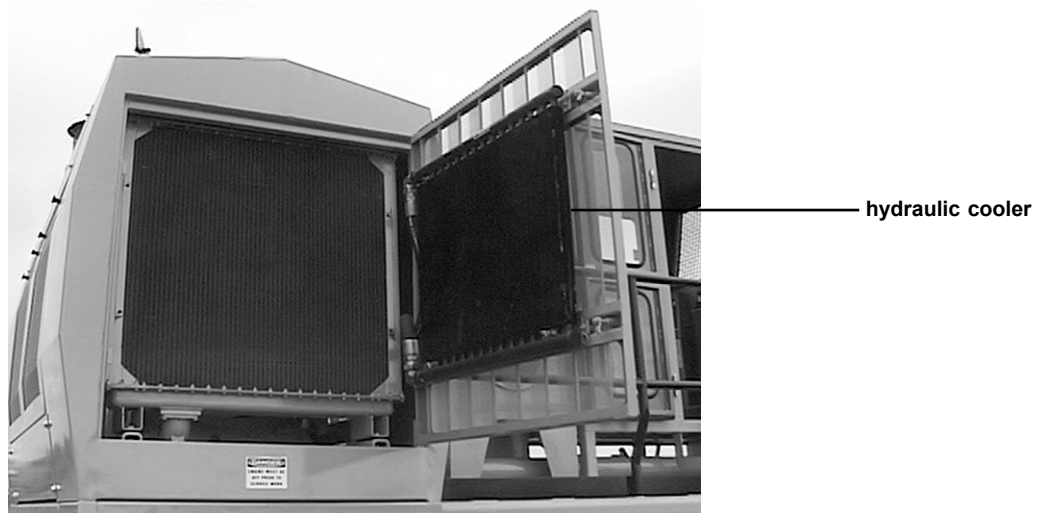

## 2.12 Hydraulic cooler

The hydraulic system dissipates excess heat by constantly flowing through a hydraulic oil cooler.





## 2.13 Starting System

The GRINDMASTER 512 engine uses a 24-volt start system, and a 24-volt lighting and accessory system.

An alternator and rectifier supplies current to maintain the starting batteries while the engine is running. The electrical system utilizes two batteries connected in series.

The starting system utilizes an oil pressure interlock to prevent starter cranking while the engine is running.

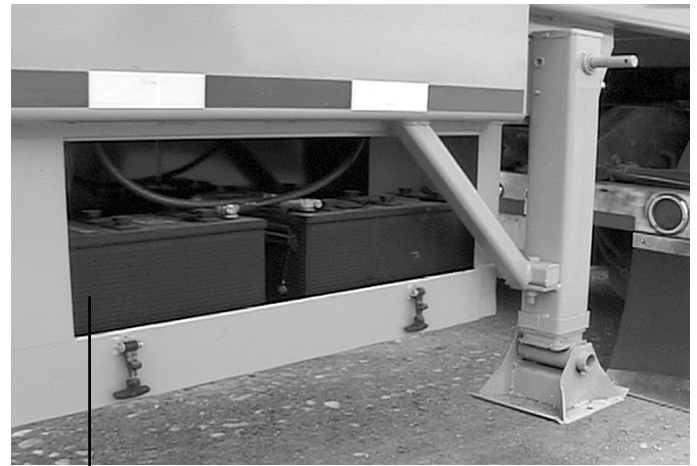

battery compartment

## 2.14 Lights

The equipment is configured with rear mounted stop, brake and turn lamps. Marker and clearance lamps are provided along the sides, front and rear of the equipment. Interior lights and instrumentation lamps are provided on the equipment.

## 2.15 Overview of the 512 operator controls

figure 2.4  
512 control panel

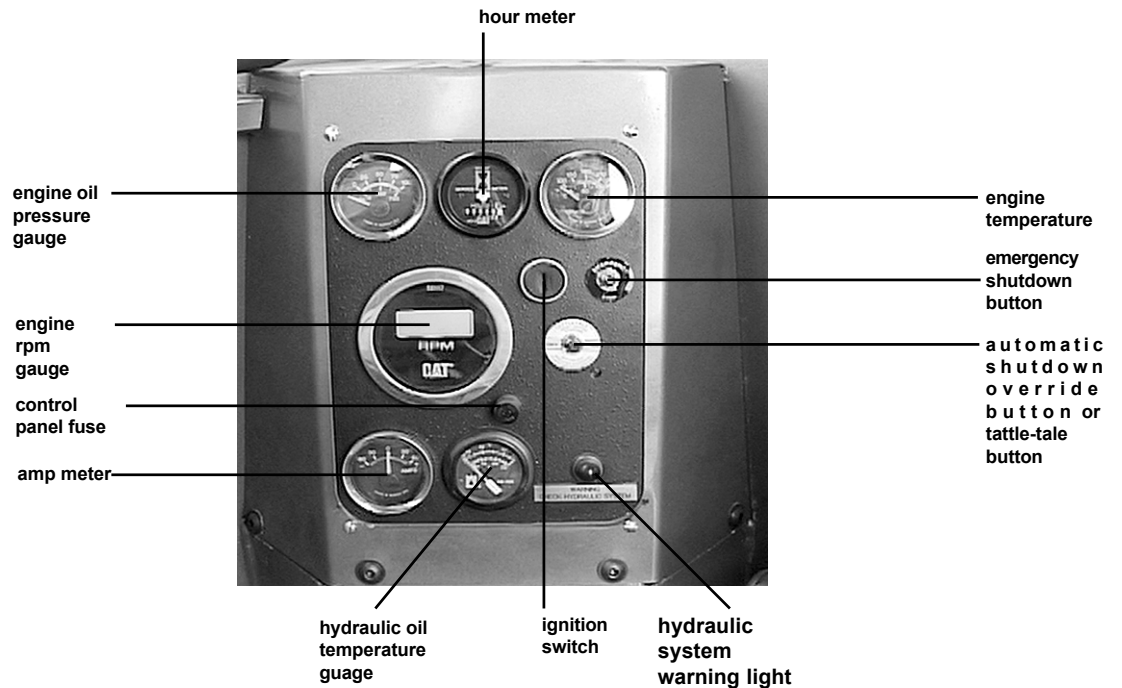



figure 2.5  
512 rotor control  
panel

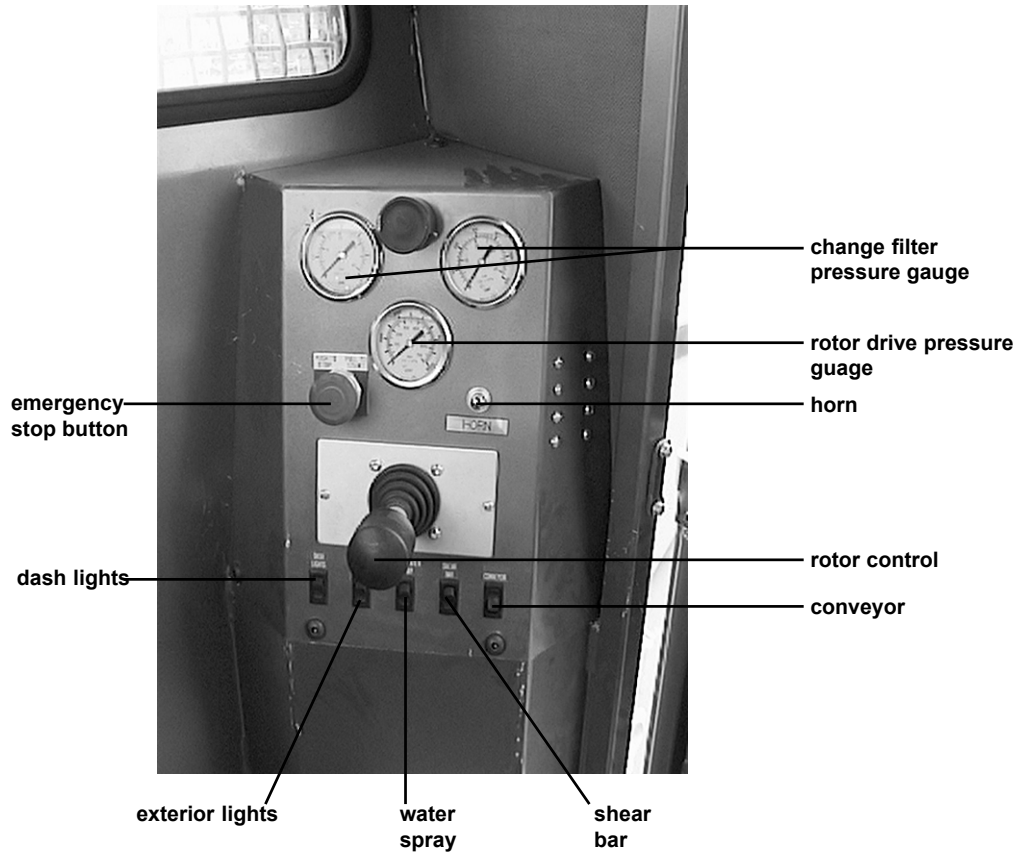

figure 2.6  
push box cylinder controls

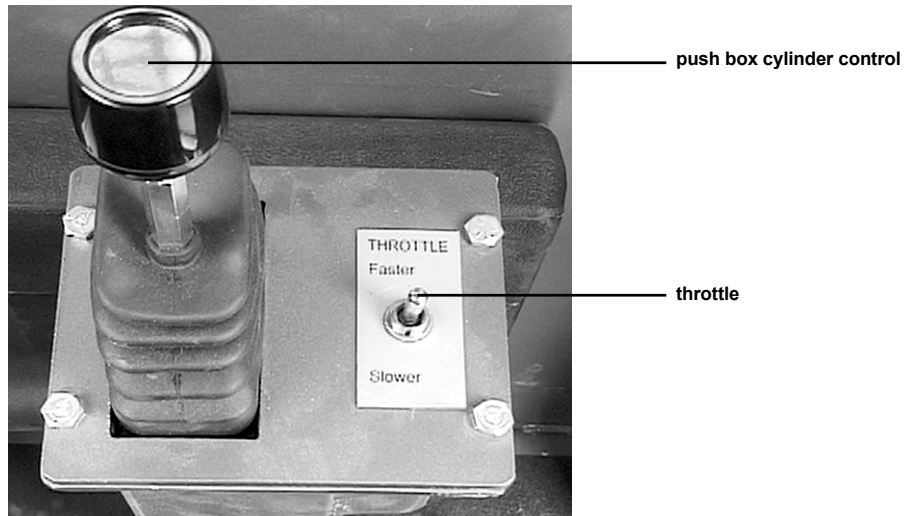
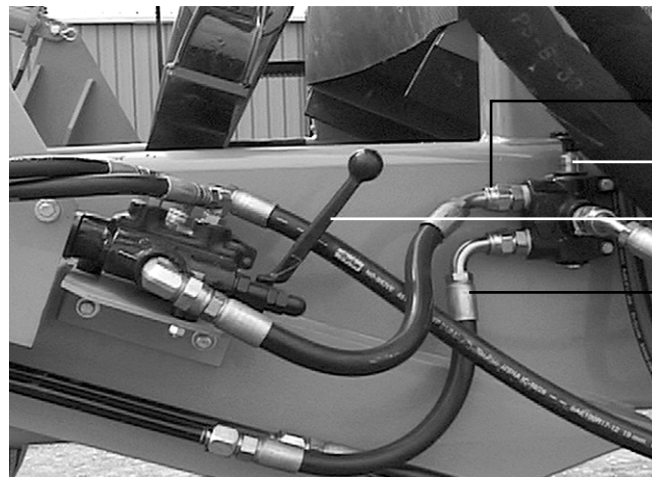

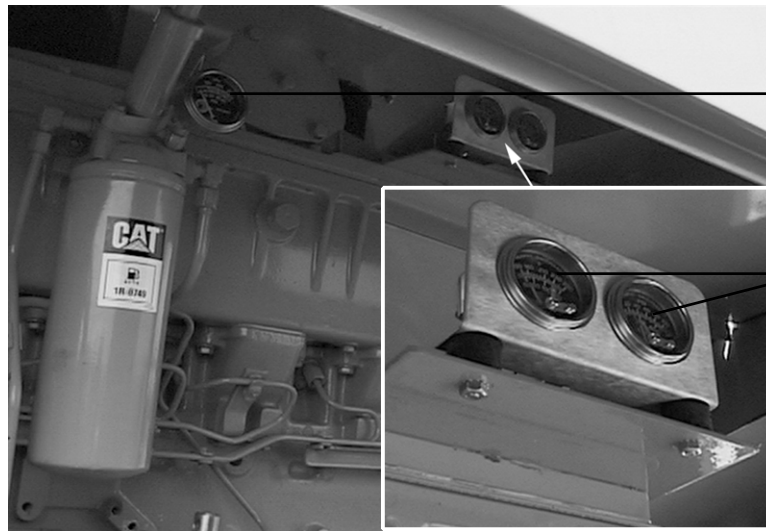

figure 2.7  
conveyor fold lever and  
conveyor shuttle valve



- to conveyor fold
- conveyor shuttle valve
- conveyor fold lever
- to conveyor motor

figure 2.8  
fuel pressure gauge and  
mechanical switch gauges  
used by automatic  
shutdown system



- fuel pressure gauge
- mechanical switch gauges  
used by automatic  
shutdown system

figure 2.13  
engine hour meter

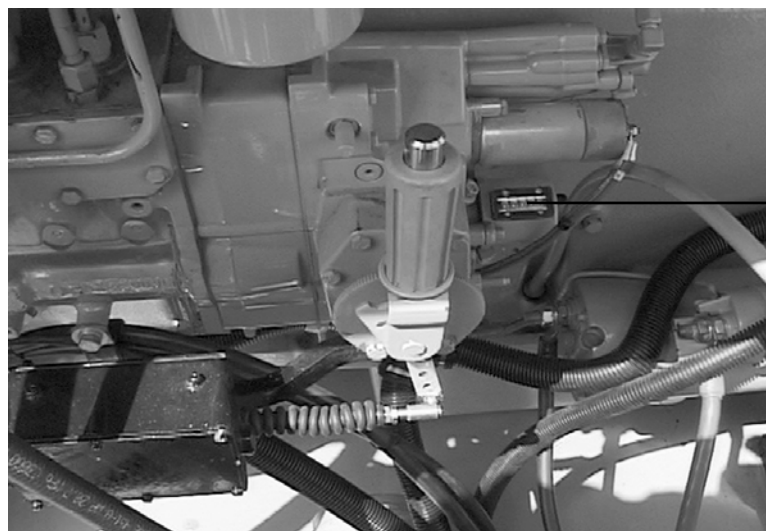

- engine hour meter



## Section 3: Operation

### 3.1 Pre-operation inspection

Read and have a thorough understanding of the operator's manual, especially the sections pertaining to machine operation and safety. Also make sure that anyone who will assist you in the operation or maintenance of this machine understands how the machine operates.

Before operating the GRINDMASTER 512, perform an inspection that includes the following items. As each task is performed, check or initial the adjacent box.



**WARNING:** Before performing the inspection, shut down the machine using the normal **shut-down procedure** which can be found on **page 22**. Make sure that the key has been removed and is tagged out.

- Check lubrication points and lubricate as recommended in the general maintenance section of this manual.
- Make sure that the machine is properly adjusted. Procedures for making adjustments to various 512 components can be found later in this section.
- Check engine oil level and coolant level, and add or change as necessary. Also look for oil or coolant leaks and repair as necessary.
- Check the hydraulic oil level, and add or change the hydraulic oil as necessary. Also check the hydraulic system for leaks.



**WARNING:** Hydraulic fluid escaping under pressure can be invisible and have enough force to penetrate the skin. When searching for a suspected leak, use a piece of wood or a cardboard rather than your hands. If injured, seek medical attention immediately to prevent serious infection or reaction.

- Check the air cleaner service indicator. If the red indicator is visible, service the air cleaner.
- Check for buildup of debris around the radiator, turbocharger, manifolds, air intake and moving parts. Remove the debris before operating the unit. Buildup of excess debris may result in fire.
- Inspect belts for cracks, breaks, or other damage.
- Inspect wiring for loose connections and for worn or frayed wires.
- Check the fuel supply, and drain any water from the water separator.
- Visually examine the rotor to see if any parts show excessive wear. Replace or repair any worn parts before operating the unit.
- Check the screens for wear. Also check the screen cage for wear and tightness. Replace or repair any worn parts before operating the unit.
- Visually examine the rotor bearings and the mounting bolts and check all bearings for wear. Replace or repair any worn parts before operating the unit.
- Make sure that all shields and guards are in place and in operating condition.



## 3.2 Starting the GRINDMASTER 512



**WARNING:** Before starting the engine, **ALWAYS** make sure that the conveyor shuttle valve is in the conveyor fold position, and that the conveyor toggle switch is in the off position. If the conveyor shuttle valve is in the conveyor run position, and the conveyor toggle switch is in the on position, the conveyor will begin to turn when the motor is started which could result in damage to the machine.



**NOTE:** The engine will start easier at cool temperatures by use of a starting aid. A block heater or other means can be used to warm the engine.

**NOTE:** Do not crank the engine for more than 30 seconds. Allow the starter motor to cool for two minutes before cranking again

Check engine manufacturers recommendations before starting the engine, and follow their recommendations where applicable.

Check for **DO NOT OPERATE** or similar warning tags. Do not move any controls if such tags are on the machine.

To start the engine, perform the following steps:

1. Perform the pre-operation inspection.
2. Set the throttle to approximately half engine speed.
3. Shout the word “**CLEAR**”.
4. Turn key on.
5. Press down the Tattle-tale button, Tattle-tale button should stay down.
6. Turn the key to the start position and release it when the engine starts.
7. Release the Tattle-tale button 10 seconds after the engine starts. If the oil pressure does not rise within ten seconds after starting, stop the engine and make the necessary repairs.
8. Reduce the engine speed to a low idle. Allow the engine to idle for 3 to 5 minutes, or until the water temperature gauge indicator has begun to rise. The engine should run smoothly at low idle.
9. Make another walk-around inspection checking the engine and hydraulic system for fluid leaks.
10. Follow the engine manufacturers recommendations for the care and maintenance of a new engine.





### **3.3 Automatic engine shutdown system**

The engine will automatically shut down if it overheats or if engine oil pressure is inadequate. If this happens, perform the following steps:

1. Check the engine oil level.
2. Inspect the radiator and clean if necessary.
3. Check tension and condition of the fan belt.
4. Allow engine to cool and check the coolant level.
5. Attempt to restart engine following the normal starting procedure.
6. If the engine will not continue running, contact a qualified mechanic.

### **3.4 Normal Shutdown Procedure**

Use the following procedure to shut down the GRINDMASTER 512 under normal operation:

1. Retract “push box.”
2. Allow conveyor belt to run until empty.
3. Disengage rotor drive.
4. Disengage conveyor drive.
5. Fold conveyor if required.
6. Follow the engine manufacturer’s recommendations for cooling the engine; generally, this consists of running the engine at 1/2 speed or idle for 5 minutes.
7. Shut off the engine and remove the key.
8. Note the service hour meter reading, and perform periodic maintenance as required.
9. Repair any leaks, perform minor adjustments, tighten loose bolts, etc.
10. Clean the machine as stated in section 1.9 Fire safety which is located on page 11.



### 3.5 Emergency Shutdown Procedure

1. Push in the engine kill button or the engine shutdown button located on the control panel and remove key.



**NOTE:** Reset engine kill button before starting.

2. Both switches should be periodically tested to ensure proper operation. Test the switch only after the engine has been running at a low idle for 3 to 5 minutes and the hydraulic controls are in their normal or off positions.
3. If the engine is shutdown while the rotor is rotating, wait until the rotor comes to a complete stop before exiting the operator's platform.



**NOTE:** Never leave the operator's platform while the grinder components are in motion, unless an emergency or critical situation dictates. Always shutdown the engine before leaving the equipment.

**NOTE:** Reset emergency stop button before starting.

**figure 3.1**  
engine shutdown button,  
tattle-tale button and engine  
kill button



**tattle-tale button**  
**NOTE:** push and  
hold down this  
button to start.

**engine shutdown button**  
**NOTE:** push and hold  
down until engine stops.



**engine kill  
button**



## 3.6 Grinding Materials



**CAUTION:** Never operate the grinder while personnel are located outside of the operator's compartment.

- A. Before grinding materials, be certain the front window guard is latched in place. Debris may be cast from the hopper during the grinding process.
- B. Ensure that there are no materials jammed in the rotor area before engaging the rotor.
- C. With the engine running at a fast idle, approximately 1000 to 1500 RPM, engage the hydraulically driven rotor as outlined in the following instructions:



- 1. Retract the shear bar to its fully open position.
- 2. Retract the push box to its rear-most position.
- 3. Engage the rotor by shifting the rotor control lever to the engaged position.
- 4. Engage the conveyor.
- 5. Increase the engine speed to its full throttle position.
- 6. Adjust the shear bar to the desired material shred gradation. Most materials can be successfully processed with the shear bar in its fully closed, fine grade position.
- 7. Load the hopper with materials, do not overload
- 8. With the hopper containing materials, extend the push box cylinder to force the materials into the rotor.
- 9. Observe the rotor pressure gauge while grinding materials. Maximum operating pressure should be maintained at or below 4200 PSI. While pressure spikes above this rating will normally be experienced during the grinding process, the push box cylinder control valve should be throttled back to avoid excessive duration of higher pressures.
- 10. As materials are forced toward the grinder, they will tend to mound upwards near the front of the hopper. To relieve this situation, reverse the direction of the push-box and retract until the materials have relieved.
- 11. Extend the push-box to resume the grinding process.





**NOTE:** Always observe operation of the grinder and its components. Note and report any trouble before or during the operation, while paying special attention to the following:

1. Drifting hydraulic cylinders.
2. Excessive oil pressure, oil leaks, and excessive oil consumption.
3. Unusual noise or vibration in the hydraulic pumps.
4. Unusual noise or vibration in the engine.
5. Unusual noise or rotation of the rotor.
6. Erratic movement of hydraulic cylinders or components.

- D. When the push-box has been fully extended and the materials are not forced forward, fully retract the push-box to expose the entire hopper for filling.



**NOTE:** When the push-box is fully extended, there is an area of dead space between the rotor and the push-box. This helps prevent over forcing excessive amounts of materials into the rotor.

- E. Signal the loader operator to commence filling.

Repeat the process outlined in paragraphs 4-9.



### 3.7 Clearing Jams

During normal operations, materials may occasionally become jammed near the shear bar and rotor. This situation occurs because of the wide variety of materials and size of materials capable of being processed by the GRINDMASTER 512.

To clear a jam situation, follow the instructions outlined below:

1. Put rotor in neutral position.
2. Fully open the shear bar gate.
3. Retract the push plate to loosen the jammed materials.
4. Reverse rotor slowly.
5. Bring rotor to neutral.
6. Adjust shear bar gate.

In the event the jam cannot be cleared by following the above steps, the following instructions must be performed:

1. Disengage the rotor.
2. Disengage the conveyor.
3. Fully open the shear bar gate.
4. Fully retract the push-box
5. Shut the engine off, take out the key and tag out machine.
6. Allow the rotor to come to a complete stop.
7. Manually remove the jammed material.
8. Resume grinding operations.



When grinding operations are completed, disengage the rotor and conveyor, and shut down the engine.



### **3.8 Belt Tracking**

Mechanics must train the belts by eliminating structural and mechanical defects so the belt will run square to a centerline.

Aim at providing the best possible conditions for the belt to move the load efficiently, reliably and without damage.

One or more of the following can influence belt tracking:

1. Idlers - troughing and return.
2. Pulleys - head and tail.
3. Structure - misalignment of conveyor sections, damage, footings.
4. Splice - mechanical, vulcanized.
5. Loading - side, center.
6. Belt - balanced construction (internal stresses) and camber or bow.

When a belt is to be placed in service on a new installation, a “pre-check” should take place. Inspect the entire conveyor line and loading stations to be sure all parts are free-moving, properly aligned and free of any debris that may cause damage.

The original equipment engineer should have already checked the following:

- A. Accurate alignment of motor drive components, which is necessary for proper operation and wear life.
- B. Head and tail pulley shafts parallel to each other.

This applies to all pulleys in the system. They should be horizontal and square with the conveyor or centerline.

The following should also be checked:

- A. All bolts joining all sections tightened.
- B. Idlers secured in line, horizontal and square with the conveyor centerline. All idlers, including self-aligning idlers must be installed properly for the direction of the belt travel, if they are of the unidirectional type.
- C. All idlers properly greased. Wipe off any excess grease that may come in contact with the line belt.
- D. Herringbone grooved pulley lagging on drive pulleys should be installed with the herringbone apex (point) pointing in the direction of the pulley rotation. Diamond-grooved lagging is not directional and direction of pulley rotation does not effect its performance.



Once the preliminary checks have taken place, it is now time for belt start-up. From this point on, whether you're dealing with a new installation or replacing a belt on an existing system, the procedures for correcting any tracking or training problems will be the same.

The conveyor should be jogged on and off for several revolutions and carefully observed at all locations. If major maladjustment or defect occurs which jeopardizes the belt, shut the system down immediately. Correct the problem area, reposition the belt and start over.

Normal tracking procedures should start with the return run working toward the tail pulley. If the belt is observed to be wandering to one side or the other, adjustment of the return idlers may be needed. Idler adjustment should start four to six idlers before the point of maximum runout and always progress in the direction of the belt travel.

To shift the idlers, loosen the mounting bolts, and with a soft hammer tap the idler frame ends until it is in position, and bolt securely in place.

The belt will run to the side corresponding to the end of the idler roll that it contacts first in its line of travel. Thus, the direction of steering is similar to steering a bicycle.

Large adjustments to one or two idlers should be avoided, as this will cause excessive wear.

A further aid to centering the belt on the tail pulley is to slightly advance and raise the alternate ends of the return rolls nearest the tail pulley.

Self-aligning idlers can be used but should not be depended upon to correct misalignment of the system by forcing the belt into correct running position. They are more properly used as an aid to initial belt training, but they are primarily a safeguard against unusual operating conditions after the belt has been properly trained.

After training has been accomplished on the return side and the belt is centered on the tail pulley, proceed as required with adjustments of the "roughing" idlers.

Troughing or carrying idlers assists in belt tracking by two methods: shifting the idlers or tilting the idlers.

The feet of the idler stands may be knocked or shifted to correct a condition in which the entire belt runs to one side along some portion of the conveyor. The belt can be centered by knocking ahead in the direction of belt travel the end of the idler the belt touches first. Shifting idlers in this fashion should be spread over some length of the conveyor preceding the region of the trouble. If the belt is overcorrected by shifting idlers, it should be restored by moving back the same idlers and not by shifting additional idlers in the other direction.

Tilting the "roughing idlers forward by no more than 2° in the direction of belt travel produces a good alignment effect. This may be accomplished by placing a steel washer under the rear feet of the idler stand.

This method has the advantage over "knocking idlers" in that it will correct movement of the belt to either side of the idler, hence is useful for training erratic belts. Some idlers have built-in angle, requiring no washers. Such idlers are unidirectional and must be mounted with the tilt in the direction of the belt travel.

Such idler shifting is effective for only one direction of belt travel. If the belt is reversed, a shifted idler, corrective in one direction, is misdirective in the other. Hence, reversing belts should have all idlers squared up and left that way. Any correction required can be provided with self-aligning idlers designed for reversing operation. Not all self-aligners are of this type, as some work in one direction only.

All pulleys should be level and with their axis at 90° to the direction of belt travel. They should be kept that way and not shifted as a means of training. Pulleys with their axis at other than 90° to the belt path will cause belt misalignment. When pulleys are not level, the belt tends to run to the low side. Because of this condition, it is important to keep all pulley surfaces clean, otherwise misalignment may occur.



Another condition that might be encountered as the belt is observed would be one section of the belt runs odd at all points. Two factors can cause this problem:

1. The belt may be improperly spliced (out of square). Check splicing directions and squaring techniques.
2. One belt edge may be longer than the other (bow or chamber). In this case, contact belt representative.

There may be cases where a belt may run erratically throughout the entire system. Observe the belt while running empty, making sure the belt is “roughing”, making good contact with all sides but not being sucked down into idler gaps. If the belt is not making good contact, it may be too stiff for that conveyor system.

After the belt has been properly trained while running empty, it should be loaded as soon as possible to facilitate breaking it in. With the belt operating loaded, check the belt again for runout. If necessary, realign idlers as previously described.

Observe loading locations. Off-center loading is harmful to belt, idlers and shafting and it forces the belt to one side, which may cause damage. Try to design a chute to load the belt in the direction of travel as well as in the center.

Follow the manufacturer’s recommendations for idler and bearing lubrication. Do not run a belt conveyor if idler rolls are seized and are not free turning. Rapid belt wear or sidetracking of the belt may result.

Tracking problems can be resolved with a little patience and an understanding of cause and effect.



**CAUTION:** Always disconnect master switch before servicing unit.



## 3.9 Conveyor

figure 3.2  
conveyor fold lever and  
conveyor shuttle valve

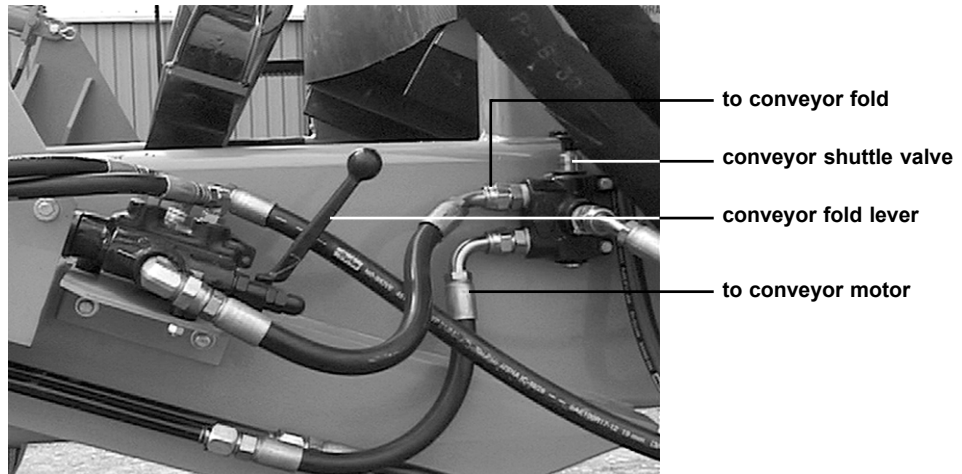

A shuttle valve is located to the right rear of the rotor. Pushing the valve down provides power to run the conveyor motor. Raising the valve up provides power to the conveyor fold mechanism.

To **fold the conveyor**, perform the following steps:

1. Check the location. Are there power lines, branches, roof trusses, etc. that will obstruct the unfolding operation of the conveyor and the loading operation of the tub?
2. Place tiedown strap on conveyor.
  - a.) Place the engine at low idle.
3. Raise the shuttle valve up so conveyor fold is operational.
4. Operate conveyor fold valve and slowly fold conveyor to transport position.



**Note:** When folding the conveyor, do not exceed an engine speed of 600 RPM. Excessive engine RPM will cause the conveyor to fold too fast and may cause damage.

5. Tighten tiedown strap when conveyor is in the transport position.
6. Turn off ignition and conveyor toggle switch. Leave shuttle valve in conveyor fold position.

To **unfold the conveyor**, perform the following step:

1. Check the location. Are there power lines, branches, roof trusses, etc. that will obstruct the folding operation of the conveyor.
2. Place the engine at low idle, and loosen tiedown strap
3. Check that the shuttle valve is in the raised position.
4. Operate conveyor fold valve and slowly unfold conveyor to desired position.
5. Make sure tiedown strap is clear of the conveyor.
6. Switch shuttle valve to lower position to run conveyor orbit motor.



### 3.10 Preparing the 512 for transport

To prepare the 512 for transport over public roads, perform the following steps:

1. Be sure all loose parts such as screens, or extra hammers are properly stowed.
2. Retract push-box fully so push-box is close to operators cab.
3. Fold the discharge conveyor into the transport position which is described on the previous page.



**NOTE:** Before transporting the Grindmater 512, verify that the conveyor tiedown strap is firmly cinched.



**CAUTION:** DO NOT MOVE THE GRINDMASTER 512 without first securing the conveyor in transport position.

4. Shut down the engine using the normal shutdown procedure.
5. Verify that the semi-tractor is properly coupled to the grinder hitch, and that the trailer wiring harness and air brake lines are properly connected to the semi-tractor.
6. Raise the trailer landing gear and lock the handle in its storage position.
7. Check the lights and the brakes for proper function.
8. Check the turning clearance between the grinder and the towing vehicle.
9. Check local ordinances regarding restrictions for machine travel on local roads.

Read the towing portion of the “Safety” section in this manual.



### **3.11 Preparing the 512 for operation after transport**

To prepare the 512 for operation after transport, perform the following steps:

1. Check the location. Are there power lines, branches, roof trusses, etc. that will obstruct the unfolding operation of the conveyor and the loading operation of the tub?
2. Lower the trailer landing gear.
3. Disconnect the wiring harness and the air brake lines from the semi-tractor.
4. Disconnect the semi-tractor from the grinder's hitch.
5. Perform pre-operation inspection of the Grindmaster.
6. Start the engine.
7. Remove the conveyor tiedown strap, and unfold the top section of the discharge conveyor until it is fully extended.

### **3.12 Preparing the 512 for storage**

To prepare the 512 for storage, perform the following steps:

1. Change the hydraulic oil and filter every 500 hours of operation.
2. To prevent rust and make inspection easier, thoroughly clean the machine.
3. Check for loose or worn chains belts, sprockets and pulleys.
4. Check the condition of bearings.
5. Make sure that the batteries are fully charged before storing the unit.
6. Change the engine oil.

### **3.13 Removing the 512 from storage**

To remove the 512 from storage, perform the following steps:

1. Perform a thorough pre-operation inspection.





## Section 4: Engine Maintenance

Engine oil level, engine coolant level, air filters, and fan belt tension should be checked daily. Follow the engine manufacturer's recommendations for the replacement of parts and fluids, and follow the manufacturer's recommended maintenance schedule. Engine specifications should be found in the Operation and Maintenance manual for the engine.

## Section 5: General Maintenance



**WARNING:** Before servicing machine, read the Service and Maintenance section of the Safety Instructions.



**IMPORTANT:** If for any reason arc welding is to be done, always ground rotor to frame of machine to prevent arcing in bearings.

### 5.1 Batteries

Check the condition of the batteries to insure that the electrolyte level is correct. Make sure that the terminals and cables are not corroded, and that the battery is held in place properly. Also make sure there is no arcing or grounding by the terminals.

The system uses two 12 volt batteries in series to produce a 24 volt system for the engine.



**CAUTION:** Hydrogen gas given off by a battery is explosive. Keep sparks and flames away from the battery. Before connecting or disconnecting a battery charger, turn the charger off. Make last connection and first disconnection at a point away from the battery. Always connect the NEGATIVE (-) cable last and disconnect the NEGATIVE (-) cable first.



## 5.2 Lubrication



**CAUTION:** Always shut off machine before adjusting or lubricating. When grinder is operated during cold weather, all lubrication should be performed after bearings are at operating temperatures.

Since a full bearing with a slight leakage is the best protection against entrance of foreign material, bearings operating in the presence of dust and water should contain as much grease as speed will permit. At higher speed ranges, too much grease will cause the bearings to overheat.

Abnormal bearing temperature during high speed operation may indicate faulty lubrication. The normal temperature may range from cool to warm to the touch. If a bearing is too hot to touch for more than a few seconds and the bearing is leaking grease excessively, there is too much grease in the bearing. High bearing temperatures with no grease showing at the seals, particularly if the bearing seems noisy, usually indicates too little grease. Normal temperature and slight showing of grease at the seals indicate proper lubrication.

The Lubrication Chart is a general guide for “relubrication”. Certain conditions may require a change of lubrication periods as dictated by experience.

A heavy-duty, general-purpose, lithium-based grease is recommended for lubricating the GRINDMASTER 512.

### LUBRICATION CHART

LUBRICATION POINTS	LUBE TYPE	FITTING	METHOD
Conveyor pulleys.	No. 2 Lithium Based	Grease	Apply until old grease is displaced. Wipe away excess.
Rotor drive bearings.	No. 2 Lithium Based	Grease	Apply until old grease is displaced. Wipe away excess.
Shear bar pin hinges	No. 2 Lithium Based	Grease	Apply until old grease is displaced. Wipe away excess.
Push box shaft head.	No. 2 Lithium Based	Grease	Apply until old grease is displaced. Wipe away excess.
Trailer dolly jacks each side.	No. 2 Lithium Based	Grease	Apply until old grease is displaced. Wipe away excess.
Hydraulic Oil.	See Section 6.3	Fill	Drain and fill.
Drive engine oil (see OEM Spec.).		Fill	Drain and fill.
Engine coolant.	Anti-Freeze	Fill Cap	Drain, flush system, fill with 50/50 water/coolant.
Pump Drive.	Gear Oil	Fill	Drain and fill.
Wheel bearings.	Oil	Fill	See OEM booklet in pocket.
Quill coupling	Falk LTG Grease (#7500791)	Grease	Repack
Quill bearings	Gear Oil	Fill	



# GENERAL MAINTENANCE CHART

ITEM/FUNCTION	ACTION	INTERVAL
<b>ENGINE</b>		
Engine oil level. Add new oil as required (see specs).	Check	Daily
Engine for rough operation or unusual noise.	Check	Daily
Engine compartment for oil, water, or other fluid leaks.	Inspect	Daily
Condition and tension of all drive belts.	Inspect	Daily
Exhaust pipes, clamps and hardware for security.	Inspect	Daily
Engine pump drive.	Check	Daily
Engine lubricating oil.	Replace	250 Hours
Engine oil filter.	Replace	250 Hours
Engine air cleaner element.	Replace	As Needed
<b>FUEL SYSTEM</b>		
Equipment fuel tank level. Fill as required.	Check	Daily
Fuel filters.	Replace	During Engine Service
<b>COOLING SYSTEM</b>		
Level and condition of engine coolant.	Check	Daily
Water pump and hoses for leaks.	Inspect	Monthly

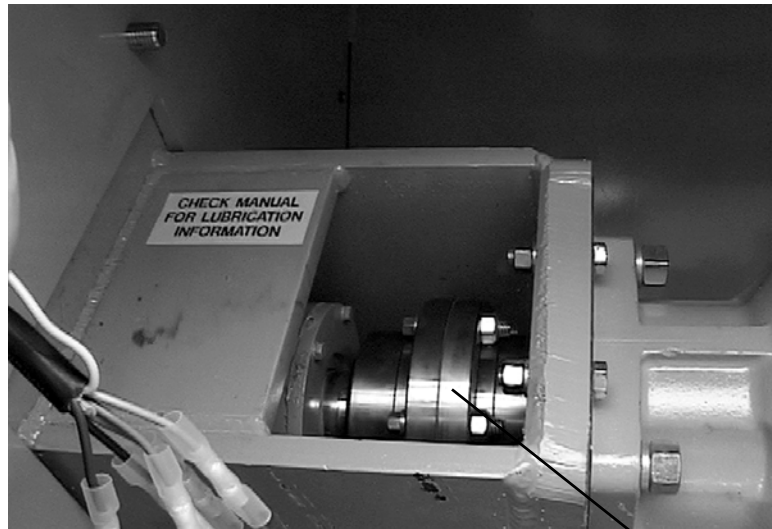

figure 5.1  
lubrication points



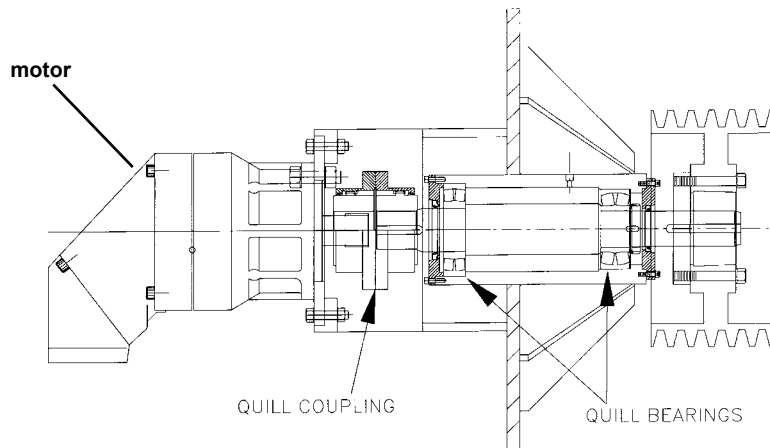

figure 5.2  
lubrication points



quill bearings

quill coupling





## 5.3 Hydraulic system



**CAUTION:** Lack of proper hydraulic oil level in the reservoir tank will cause system to heat under continuous running. Check the hydraulic oil level daily and replace as necessary.

Both hydraulic oil filters should be changed after the first 10 hours of operation. Change hydraulic oil and filters after the first 100 hours of operation. Thereafter, change hydraulic oil and filters every 500 hours of operation.

Check the hydraulic oil regularly, and if the oil has a burnt smell or milky appearance, change it immediately.

When adding or replacing hydraulic oil, use ISO 46, zinc free hydraulic with **NO** anti-wear additives, such as filtered MOBIL DTE Heavy Medium or TEXACO Rego RO type PC.

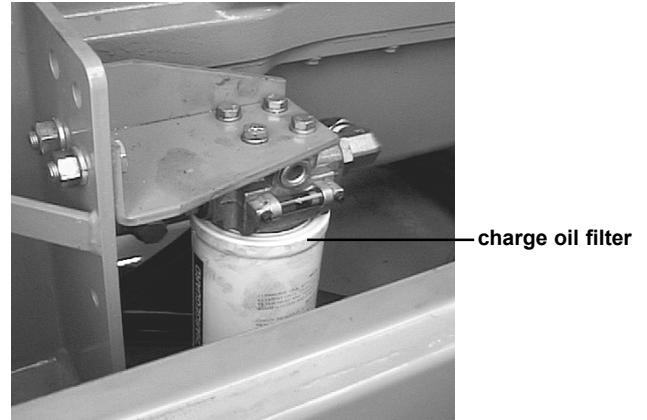

figure 5.3  
hydraulic oil tank  
breather





## 5.4 Axle, wheels and tires

### TIRE PRESSURE

Set the tire pressure according to the manufacturer's specifications. The appropriate tire pressure can be found on the sidewall of the tire.

### WHEEL BEARINGS

The wheels have tapered roller bearings in an oil bath. Each hub is equipped with a transparent oil cap which has an oil level indicator mark that allows for easy checking of the oil level. The oil level should be checked daily during the pre-operation inspection. This lubrication method assures long bearing life with proper maintenance of the oil level.

figure 5.4  
hub equipped with  
transparent oil cap



When adding or replacing oil in the wheel bearings, use SAE 80W-90 HYPOID GEAR OIL.



## 5.5 Brake component lubrication

A schedule for the periodic lubrication of brake components should be established by the operator on the basis of past experience and the severity of operating conditions.

### GUIDELINES

- **For camshaft roller journals:** Lubricate with high temperature anti-seize grease.
- **For anchor pins:** Lubricate with high temperature anti-seize grease.
- **For manual slack adjusters:** Lubricate with NLGI Grade 2.
- **For automatic slack adjusters:** Lubricate with ASA manufacturer's recommended lubricant.

### FREQUENCY OF SERVICE

Camshaft roller journals, anchor pins, slack adjusters every 25,000 to 30,000 miles or every six months depending on severity of operating conditions. (For off highway use: service every 4 months depending on severity of operating conditions.)



**CAUTION:** Care must be exercised when lubricating the camshaft bushings and anchor pins. Over lubrication could cause a safety problem as brake linings become saturated with lubricants.



**NOTE:** When reline shoe linings become saturated with grease, replace with new shoe and lining assemblies.

### SUGGESTED PREVENTATIVE MAINTENANCE

- **Every 1,000 miles:** Check oil level in wheel hub and inspect wheel for leaks.
- **Every 15,000 miles:** Check brake adjustment. Repack wheel bearings (grease application).
- **Every 25,000 to 30,000 miles:** Check lining wear and estimate reline time. Inspect camshaft, camshaft spider bushing and camshaft support bracket bushing for any signs of wear. Lubricate brake actuating components.
- **Every 100,000 miles, once a year, or at brake reline:** Replace wheel bearing lubricating oil (if applicable). Check brake air chambers and slack adjusters. Inspect brake rollers, roller shafts, anchor pins and bushings and replace if necessary.





## 5.6 Rotor bearing installation



**WARNING:** To ensure the rotor is not unexpectedly started, turn off and lock out or tag the power sources before proceeding. Failure to observe these precautions could result in bodily injury.



**NOTE:** Bearing housing caps and bases are not interchangeable and must be matched with mating half. Install the non-expansion bearing first.

1. Apply a light coating of oil or other rust inhibitor to the adapter area of the shaft.
2. Measure the internal clearance of the bearing before mounting. Place the bearing in an upright position. Seat the inner ring and roller elements by pressing down firmly on the inner ring bore while rotating the inner ring a few times. Position the roller assemblies so that a roller is at the topmost position on both sides. Using a feeler gauge, measure the clearance on both sides of the roller by inserting the feeler gauge as far as possible and sliding over the top of the roller. Write down the measured clearance for use in step 3E.



**NOTE:** Do not rotate bearing when the moving feeler gauge is between the roller and the outer ring. Refer to figure below for illustration.

figure 5.5  
rotor bearing

**NOTE:** Large cavity of Pillow Block Housing must be on the same side as locknut.

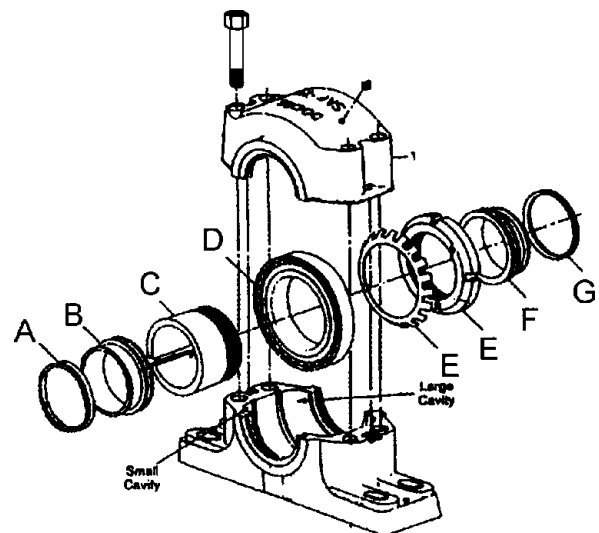



3. Install the bearing parts in the following sequence.



**NOTE:** There is only one way to correctly install the bearing. Refer to Figure 5.5 for illustration.

#### **A. V-ring Seal**

Slide one of the V-ring seals onto the shaft, making sure the lip is toward the bearing. Set aside until step 11.



**NOTE:** Do not install the V-ring seal on the seal until the housing cap has been set in place and tightened.

#### **B. Seal Ring**

Install a seal ring on the shaft with the largest OD toward bearing.

#### **C. Adapter**

Slide the adapter onto the shaft, with the threaded end outboard, to the approximate location of the bearing. Apply a light coating of oil to sleeve OD. Do not use grease.

#### **D. Bearing**

Make sure that the roller clearance has been written down. Install the bearing on the adapter sleeve with the large end of the tapered bore first. Locate the bearing in the proper position on the shaft.

#### **E. Lockwasher and Locknut**

Install the lockwasher on the adapter with the inner prong located in the slot and facing toward the bearing. Install the locknut, with the chamfered face toward the bearing. Tighten the locknut using a spanner wrench and hammer until the clearance noted in step 2 is reduced by 0.0020 to 0.0026 inch. During this step, the shafts should be supported, so that all weight is off of the bearing. Find a lockwasher tab that aligns with a locknut slot and bend the tab into the slot. If the slot is past the tab then tighten the locknut to meet a washer tab.

#### **F. Seal Ring**

Install a second seal ring with the large OD toward locknut.

#### **G. V-Ring Seal**

Slide the second V-ring onto the shaft, again making certain that the lip is toward bearing.



**NOTE:** Do not install V-ring seal on seal ring until housing has been set in place and tightened. See Step 11.



4. Remove any paint, dirt or burrs from the mating surfaces of the housing halves. Thoroughly clean the seal grooves on both sides. Set the lower half of housing on the base with all four cap bolts in place, and apply oil to the bearing seats. Apply grease to the seal grooves in the lower housing.

Be sure the housing is positioned as shown in Figure 5.5 view relative to adapter nut.

5. Apply lubricant to the bearings and the seal rings. The lubricant should be smeared between the rolling elements. Use Mobil SHC-626 or similar oil for bearing lubricant. Do not use detergent motor oil!
6. Place the shaft with the bearing into lower half of the housing while carefully guiding the seal rings into the housing grooves.
7. Bolt the lower half of the non-expansion bearing housing to the base. Move the shaft endwise so that stabilizing ring can be inserted between the bearing's outer ring and the lower half shoulder of the housing on same side as the locknut. Make all other bearings on the same shaft expansion bearings by centering in the middle of their housing seat. Bolt the expansion housings to base.



**NOTE:** Only one bearing per shaft is non-expansion, other bearings should be expansion.

8. When a closed end is required, the end plug supplied should be fit into the center seal ring groove of the housing.
9. Lubricate the bearing seal grooves in the housing cap and place over the bearing after wiping the mating surfaces. The two dowel pins will align the cap with the lower housing half.



**NOTE:** Each cap must be matched with its mating lower half, as these parts are not interchangeable.

10. Tighten the cap bolts and nuts to 208 to 260 ft-lbs.
11. Make sure that there is enough seal running clearance, and then install V-ring seals onto the seal rings and coat the V-ring seals with grease.
12. Misalignment of the pillow blocks must not exceed  $1/2^\circ$ .



## 5.7 Rotor bearing maintenance



**WARNING:** To insure that drive is not unexpectedly started, turn off and lock out or tag power source before proceeding. Failure to observe these precautions could result in bodily injury.

Remove the housing cap in order to inspect the bearing and lubricant. Before reassembly, it is important that the V-ring seals be removed. This will ensure that the seal lip will not be damaged while setting the cap in place. Reassemble the rotor bearing using steps 9 through 11 above.

## 5.8 Seal Replacement

When removing a bearing it is recommended that V-ring seals and seal rings be replaced.



## Appendix A: Warranty

DuraTech Industries International Inc. warrants to the original purchaser for 12 months from purchase date that this product will be free from defects in material and workmanship when used as intended and under normal maintenance and operating conditions. This warranty is limited to the replacement of any defective part or parts returned to our factory in Jamestown, North Dakota, USA, within thirty (30) days of failure.

This warranty shall become void if in the judgment of DuraTech Industries International, Inc. the machine has been subject to misuse, negligence, alterations, damaged by accident or lack of required normal maintenance, or if the product has been used for a purpose for which it was not designed.

All claims for warranty must be made through the dealer which originally sold the product and all warranty adjustments must be made through same.

This warranty does not apply to tires or bearings or any other trade accessories not manufactured by DuraTech Industries International Inc. Buyer must rely solely on the existing warranty, if any, of these respective manufacturers.

DuraTech Industries International Inc., shall **not** be held liable for damages of any kind, direct, contingent, or consequential to property under this warranty. DuraTech Industries International Inc., cannot be held liable for any damages resulting from causes beyond its control. DuraTech Industries International Inc., shall **not** be held liable under this warranty for rental costs or any expense or loss for labor or supplies.

DuraTech Industries International Inc., reserves the right to make changes in material and/or designs of this product at any time without notice.

This warranty is void if DuraTech Industries International Inc. does not receive a valid warranty registration card at its office in Jamestown, North Dakota, USA, within 10 days from date of original purchase.

All other warranties made with respect to this product, either expressed or implied, are hereby disclaimed by DuraTech Industries International Inc.



# Appendix B: SPECIFICATIONS

## General

Weight .....	52,000 lbs.
Transport Length.....	46' (552")
Transport Height .....	13' (156")
Axle .....	(2)-22,500 lb. axles
Tires .....	(8)-225/70R R22.5 16 Ply
Brakes .....	Air brakes
Fuel Capacity .....	175 U.S. gallons
Lights .....	Stop, tail, turn and clearance

## Grinder

Hopper .....	181" long x 60" wide x 57" deep
Operator Cab .....	105 cubic feet
Rotor Drum .....	60" wide x 38" diameter
Drive .....	SMA rotary power
Push Cylinder .....	5" diameter
Cut Plate .....	hardened steel, adjustable
Rotor Type .....	hydraulically driven reversible
Conveyor .....	60" wide x 26-1/2' long
Electrical .....	24 volt start, lighting and instrument

## Engine

Make .....	CAT
Model .....	3406
Cylinders .....	6
Horsepower .....	425 HP

## Hydraulic System

Type .....	load sense system
Main Hydraulic Pump .....	closed loop system
Drive .....	engine driven
Displacement .....	260 cc
Pressure .....	5000 psi
Flow .....	150 gpm
Cooling .....	oil cooler
Filter .....	5 micron full flow
Hydraulic Oil Capacity .....	200 U.S. Gallons



## **GRINDMASTER 512 Documentation Comment Form**

DuraTech Industries welcomes your comments and suggestions regarding the quality and usefulness of this manual. Your comments help us improve the documentation to better meet your needs.

- Did you find any errors?
- Is the information clearly presented?
- Does the manual give you all the information you need to operate the equipment safely and effectively?
- Are the diagrams and illustrations correct?
- Do you need more illustrations?
- What features do you like most about the manual? What features do you like least?

If you find errors or have specific suggestions, please note the topic, chapter and page number.

---

---

---

---

---

---

---

---

---

---

---

---

---

---

---

---

---

---

---

---

---

---

---

---

Send your comments to:

DuraTech Industries International, Inc.  
P.O. Box 1940  
Jamestown, ND 58402-1940

Thank you for taking the time to help us improve our documentation.